

SCORPION™ E2

DRAIN CLEANER RANGE

PSI
4000 - 5075

L/PM
20 - 31

ENGINE TYPE
V-TWIN PETROL
& EFI 630-800 cc





SCORPION™ G2

The Jetwave Scorpion™ G2 range revolutionises the petrol v-twin driven water jetting machine. Australian engineered and assembled; its innovation provides plumbers with a compact powerful, safe and easy to use unit that encompasses world first technology an all new Stainless Steel Exoskeleton (PEXO™) & multi-configurable design. This is the NEW Scorpion G2 family from Jetwave.

HERO INNOVATIONS



Stainless Steel Exoskeleton (PEXO™)



Smart customisable modular build.



Centralised control for safety and effectiveness



Anti-vibration Protection System (AVPS™)



JW™ Premium Italian pumps.



Skid configuration, with integrated forklift pockets/ mounting points.

MAIN FEATURES

Genuine HONDA™ Australia Approved

Slow speed pump

Large 40L on-board water tank

JW™ Triplex Italian pump

Professional nozzle kit

Wash down lance

FIELDS OF APPLICATION

Plumbing businesses & contractors

Tree roots and debris removal

Grease, sludge & dirt removal

Municipality contractors

State and local council

A REVOLUTIONARY HIGH VELOCITY HIGH PRESSURE JETTING SOLUTION

Drawing upon Jetwave's 30 years expertise, the Scorpion G2 was born in conjunction with plumbing professionals.

Innovation isn't just making something different, it's making it safer, easier, faster, more practical and efficient than ever. This cutting edge product is made specifically for plumbers. It has been designed, developed, manufactured and quality assured by a specialist team; passionate to provide the next step in water jetting equipment innovation and evolution.

Why? Because we knew things could be better.

Because perception of your service starts with how your equipment looks we invest time and money into attractive, functional, automotive inspired design.

Through a turn key, out of the box solution, that you spec your way. This enhanced solutions contribute to building your business through better tools. Equipment that is functional and technologically advanced to the point that its reliable day in and day out.

We aim to add more value than ever before and we guarantee a smoother application, specific installation and operational life that will yield increased return on your investment and contribute to grow your business in the area of plumbing pipe/drain maintenance blockage clearing.

SCORPION™ G2



PVC Pipes



Sewer Lines

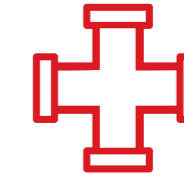

Branch Sewer Lines



Stormwater Pipes



Sinks and Vanities



Bathtubs



Roof Drains



Shower Stalls



Yard & Lot Drains



Floor Drains



Toilets



Urinals

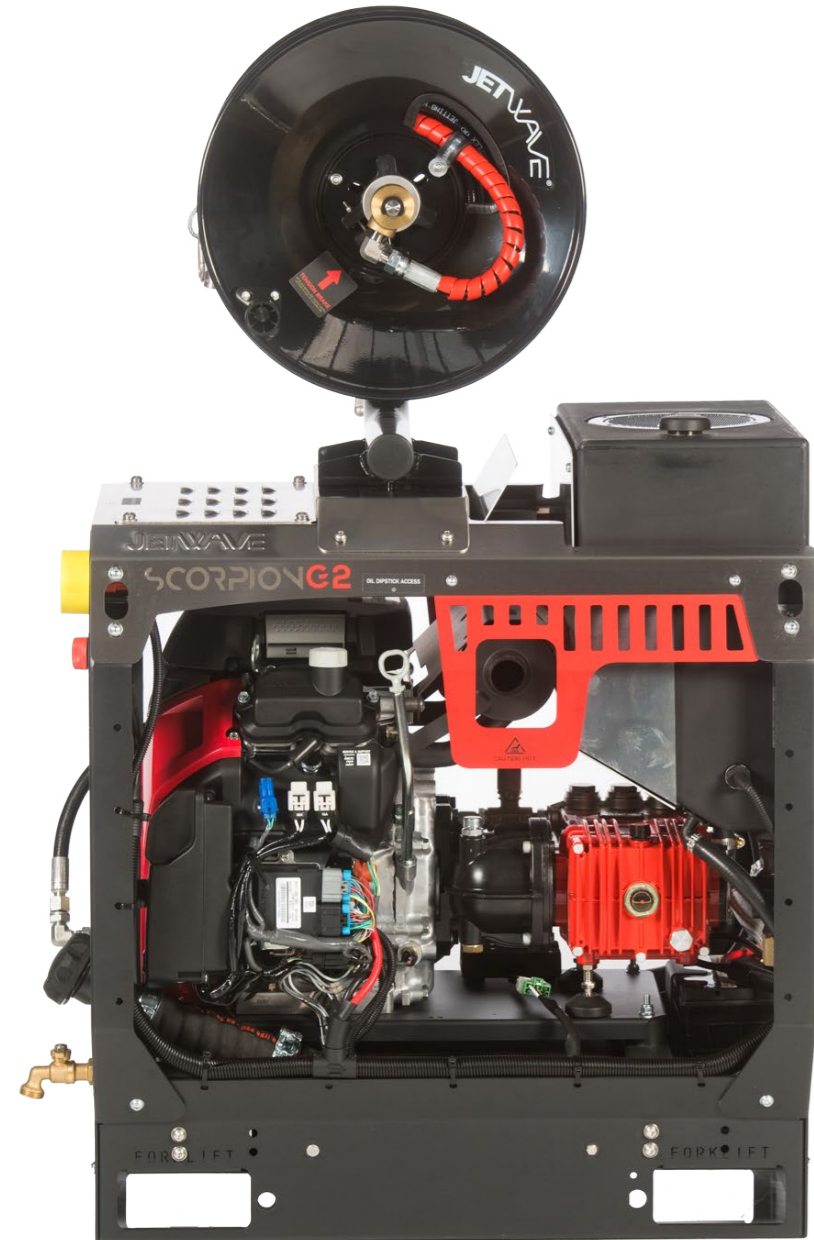

We are here to meet your water jetting needs with a product categorically developed for the professional plumber.

WHAT

A product that embodies the most innovative in design and performance for plumbers to utilise in their drain cleaning maintenance business, to leverage and create versatility in an all-in-one configurable solution fit for your exact application.

HOW

This is a bid to decrease your need for fabrication customisation, installation time, vehicle configuration flexibility and to clear blockages quicker. To increase business efficiency that will deliver you more results, time and money.

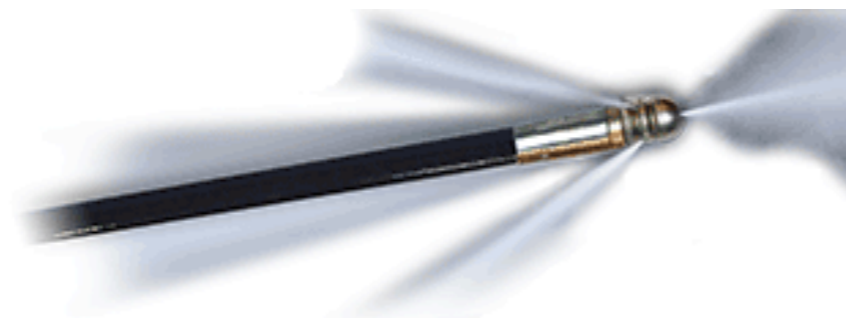

WHY

Why use water jetting over traditional methods of drain cleaning? This method has rapidly grown over the past several years and in the past manufacturers have adapted other equipment to meet market demands, as mix of operator friendliness, safety, performance and technology had yet to be developed for this market and optimised for users needs.

A water jet sends highly pressurised water through a nozzle at the end of a hose, which is inserted into the drain pipe line. The Scorpion G2 range provides an array of exotic nozzles to suit different blockages.

Scorpion G2 offers more versatility for cutting and flushing through blockages. It is safer due to its design and proper component selection built from the ground up, water jetting is typically more effective, and less strenuous compared to other traditional methods. All the while power scrubbing and scouring the inside of the pipeline to near new condition.

These water jetting machines are outstanding for heavy-duty cutting and flushing jobs such as:

- Tree root intrusion
- Storm water
- Fat, oil & grease
- Sand
- Sediment & dirt
- Soap
- Leaves
- Paper

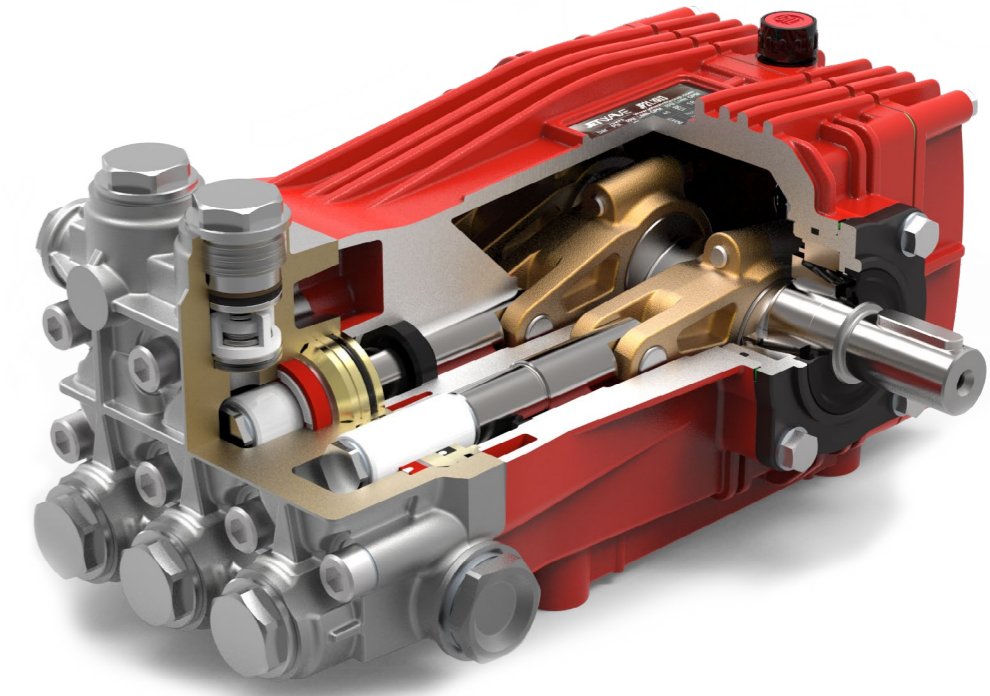



Residential



Homeowners will see investment with your professional specialised machinery. Add a specialist service and contribute to your businesses improved charge out rates.

Industrial



Heavy industry can produce some heavy duty waste. You need the most powerful, effective and efficient equipment to provide scope for your pipe/drain cleaning business.

Commercial



From the local bakery to larger commercial office buildings, Scorpion G2 gets the job done powerfully so you can win more jobs and get back to more business.

Municipal



Municipal sewer, pipe and drain cleaning. This will provide the scope to spec up or down depending on application. We aim to provide you more versatility to tender and win jobs with cost effective investment into equipment and available options.

SCORPION™ G2

A decisive step into the future of water jetting technology with a product categorically developed for a mid-tier domestic / commercial pipe cleaning plumbing professional.

Scorpion™ G2 dramatically improves the most significant aspects of a water jetting machine, and the overall experience.

It introduces world first innovative design and feature level on a jetting system. The best performance, and life protection ever in such machinery. A range of endless mounting possibilities with our multi-configurable design you can select the mounting option that suites your business needs.

A CNC formed protective stainless steel exoskeleton provide protection from the elements for the life of your investment, It looks every bit as powerfully cutting edge as it is.

This is the
Scorpion™ G2.



SCORPION G2 PRODUCT VIDEO





MULTI CONFIGURATION



MULTI CONFIGURATION VIDEO

FLEXIBILITY

New versatility suitable for almost any mounting arrangement you can imagine due to its industry leading compact modular design and configuration options.

Because the Scorpion G2 takes up less space it allows you to carry more gear and equipment so you're ready for anything.

BENEFITS

- 01 Spec the unit your exact way in the fleet.
- 02 Get your optimal machine set-up the way you want it.
- 03 Increase your space and productivity by optimal vehicle layout.
- 04 Extended versatility of the equipment in the fleet in case of any vehicle changes / upgrades.
- 05 Maximise vehicle storage space.
- 06 No ad-hoc unit fabrication.
- 07 Kit optionals available.
- 08 Multiple hose reel configurations.
- 09 More portable and uses less space in vehicle or jobsite.

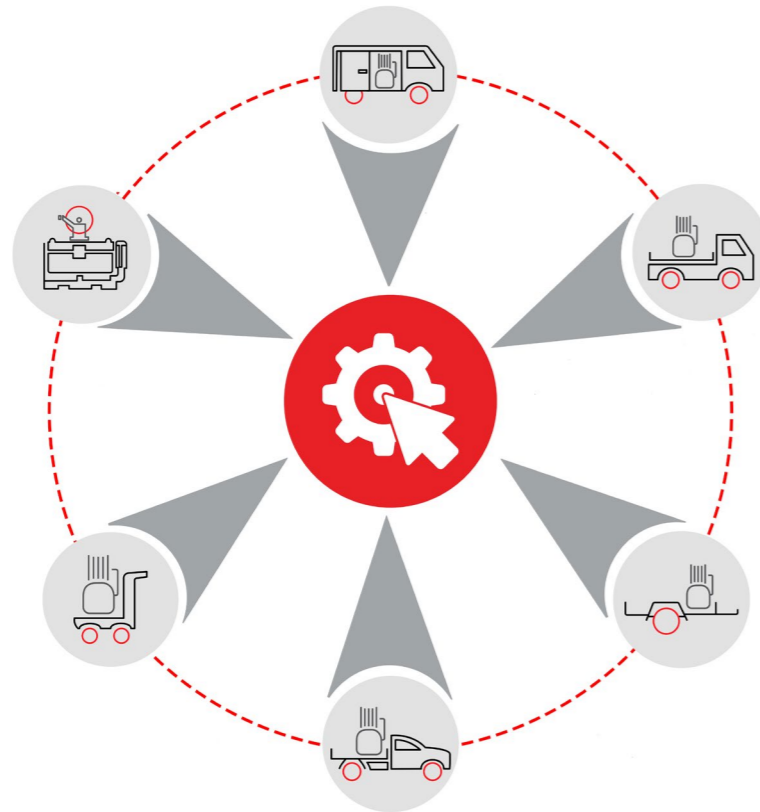

15%
LESS CUBIC SPACE
THAN THE COMPETITION



CENTRALISED CONTROL



CENTRALISED CONTROL VIDEO

PANEL MOUNTED CONNECTIONS

Easily accessible front facing and panel mounted controls in order to maximise effectiveness, operator friendliness and mounting configuration.

BENEFITS

- 01 By having all control points accessible from one side it allows the user to quickly adjust pressure or stop the machine completely in an emergency.
- 02 Provides ease of plug & play connections for any mounting arrangements.
- 03 Having all components panel mounted reduces the risk of key components breaking, decreasing service costs and increasing reliability.

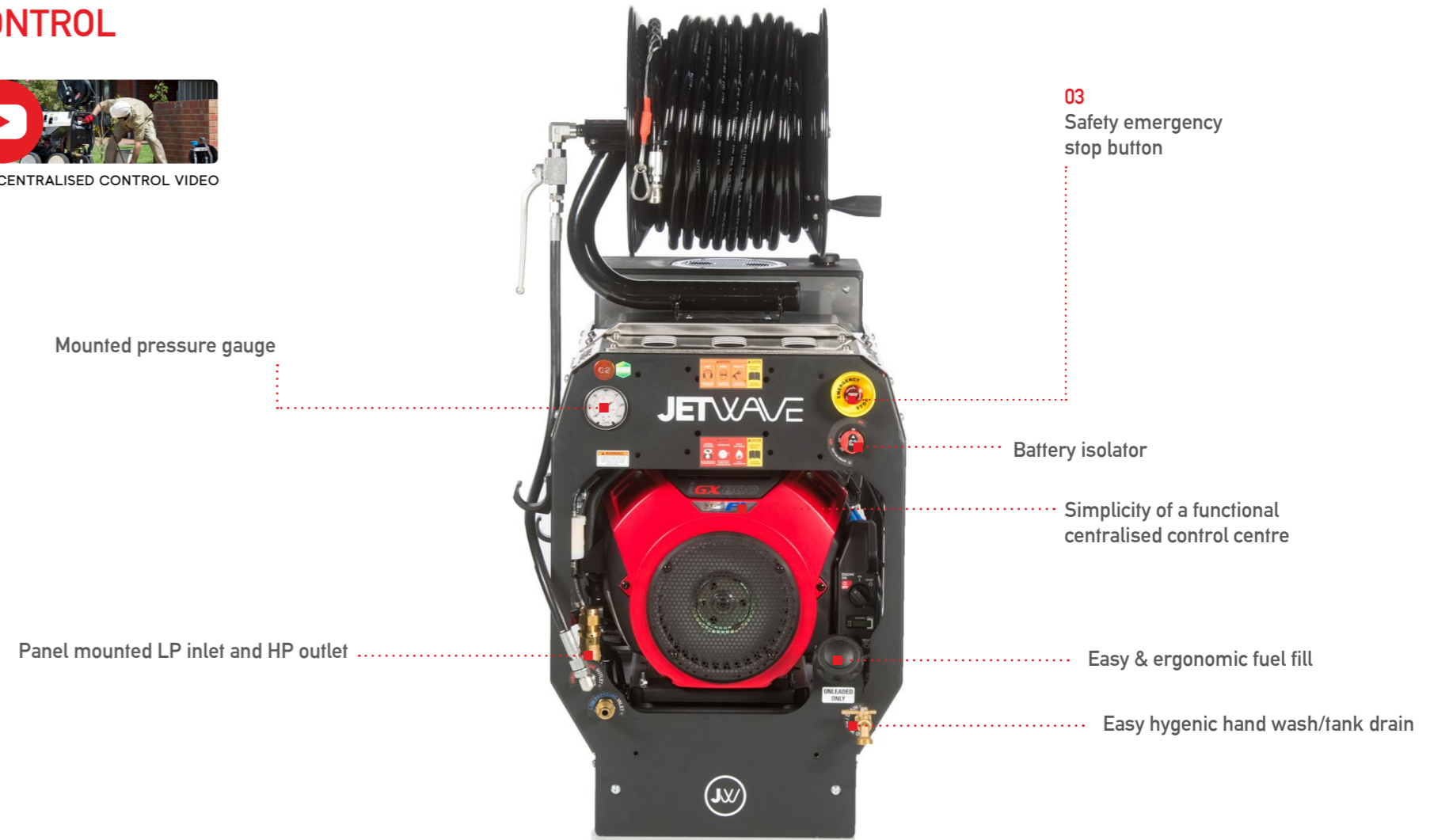



STAINLESS STEEL EXOSKELETON (PEXO™)



STAINLESS STEEL EXOSKELETON VIDEO

LIFELONG PROTECTION

The industrial precision CNC formed Stainless Steel exoskeleton provides enduring protection to the entire machine and importantly its critical working components protecting it from harsh outdoor weather elements and overspray.

BENEFITS

- 01 World first Jetwave exclusive..
- 02 Unit and operator safety maximised.
- 03 Made of heavy duty formed stainless steel.
- 04 New attractive and aesthetic design.
- 05 All critical components are still reachable for maintenance / minor repair operation.
- 06 Longer working life of your investment.
- 07 Increases reliability.
- 08 Mitigates risk of down time.
- 09 Easy removable cover for serviceability and maintenance checks.
- 10 Extend maintenance intervals.
- 11 Increased worksite safety.



ANTI-VIBRATION PROTECTION SYSTEM (AVPS™)



AVPS PROTECTION SYSTEM VIDEO

QUIETER & LONGER LIFE

The AVPS™ (Anti-Vibration Protection System) contributes to a quieter performance. It has a heavy duty steel motor plate to separate vibration frequency created from the power plant via high duro rubber and enforced steel dampeners.

BENEFITS

- 01 Contributes to quieter smooth operation.
- 02 Longer trouble free life.
- 03 Rust resistant galvanised steel independent motor plate.
- 04 4 x anti-vibration motor plate mounts.
- 05 Protection from overall frame distortion /weld cracking or damage.

Anti-vibration damper



Motor mount plate

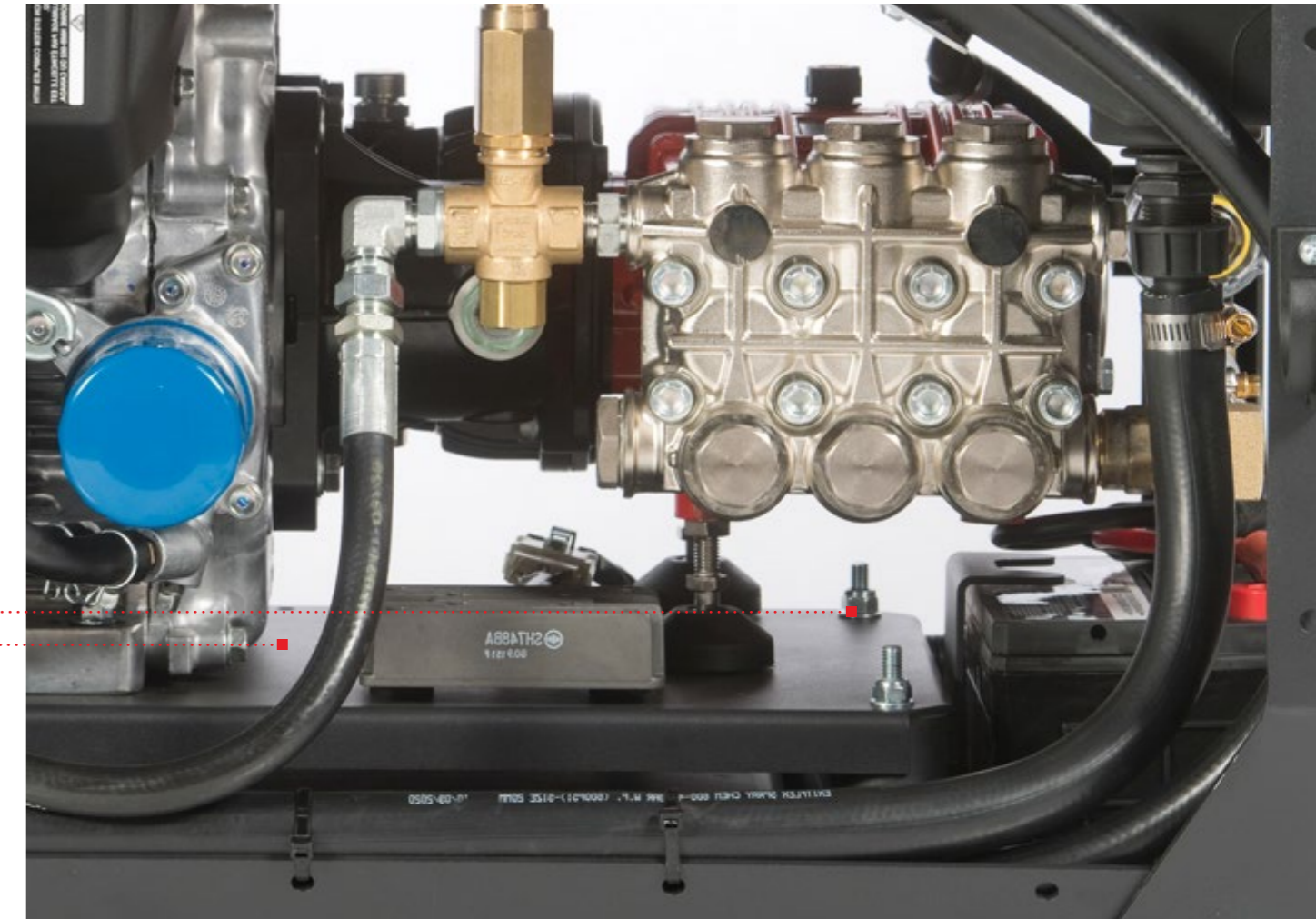



SKID CONFIGURATION



FORKLIFT POCKETS/SKID VIDEO

ERGONOMIC & VERSATILE

The skid design ensures the unit remains well planted at all times, preventing run-aways.

For transportation the forklift pockets and top lift access provide safety and convenience.

BENEFITS

- 01 Better maneuverability on-site and around jobs.
- 02 Secure your in vehicle load easily.
- 03 Tie down points.
- 04 Easy integrated flatbed mounting.
- 05 Forklift access for easy lifting.
- 06 Trolley kit available (optional)



Forklift Pockets/
Mounting Points

SHOWN WITH OPTIONAL FRONT DOUBLE STACK KIT

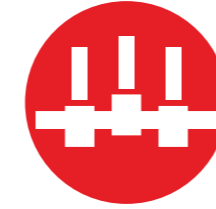

JW PREMIUM PUMPS



JW PREMIUM PUMPS VIDEO

LOW MAINTENANCE & HIGH EFFICIENCY

The finest quality Italian raw materials are used in the newly developed JW Premium Pump range, it redefines the bench mark of quality. Designed in close cooperation with the ISO9001 research & development department of one of the worlds largest plunger pump manufacturers, this pump series is packed with exclusive innovative solutions to improve pump performance, reliability and longer life.

This new premium pump range guarantees the highest levels of reliability on the market even in the harshest of working conditions.

BENEFITS

- 1 NEW overall enhanced efficiency and aesthetic performance pump design.
- 2 NEW Extended/oversized rear crankcase to reduce oil temperatures and to run cooler for longer.
- 3 'Ni' Nickel treated brass forged manifold for anti-corrosion, and better resistance to fatigue
- 4 Magnetic oil drain plug to attract all microscopic material.
- 5 Red powder coated die cast aluminum crank case. Resulting in MORE Corrosion resistance.
- 6 Unique blended NBR seals for a longer life in heavy duty application.

- 7 Dust cover for seal protection in dirty environment.
- 8 Glass fibre impregnated valve cages for higher temperature resistance
- 9 Oversized Plunger guide with 'step' diameter for longer seal life.
- 10 Large, easily visible oil level sight glass.
- 11 Oversized two piece Bronze Conrods in special low friction bronze alloy to improve load distribution.
- 12 Premium quality bearings, for lower friction to ensure lower operating temperatures.
- 13 Teflon based gasket on rear cover to ensure better sealing at high oil temperature.
- 14 Extra thick solid ceramic pistons for greater durability to wear & thermal shock.
- 15 Stainless steel high volumetric efficiency inlet & delivery valves for greater cleaning performance

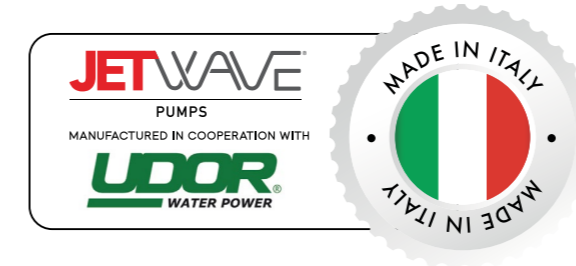
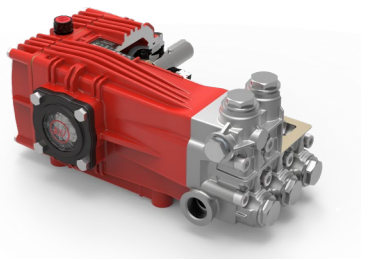
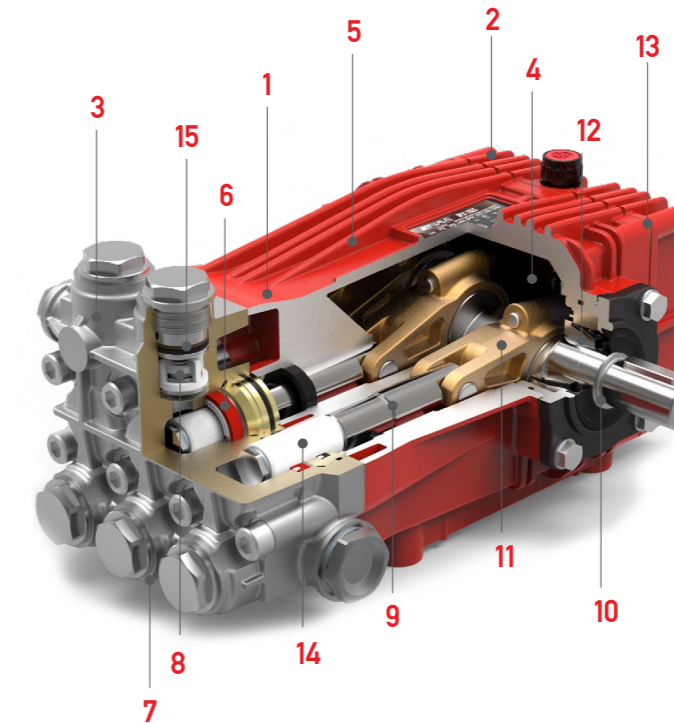

OPTIONAL UPGRADE

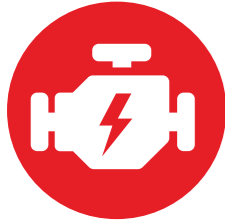

EFI ENGINE



HONDA IGX800/700 VIDEO

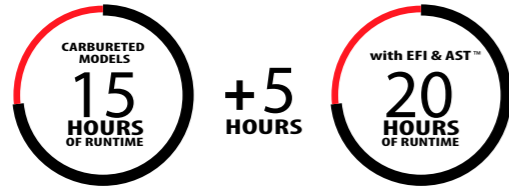

JETWAVE
POWERED by
HONDA



OPTIMISED & EFFICIENT

The V-Twin Honda iGX 700/800 petrol engine delivers some of the best power, performance and reliability in its class. With its automotive style EFI closed loop technology it optimises all engine speeds and loads.

BENEFITS

- 01 Yields a 25% decrease in fuel consumption (multiplies with auto-speed technology).
- 02 Quieter operation.
- 03 Save on running and maintenance costs.
- 04 Meets global emission compliance.
- 05 Environmentally friendly option.
- 06 Easy start with air fuel altitude compensation.
- 07 Global parts availability and back-up service network.
- 08 Matched pump to engine load.
- 09 Exclusive flat style air cleaner for more compactness.
- 10 Improved state fuel resistance.



ONLY WITH iGX MODELS



AUTO-SPEED TECHNOLOGY (AST™)



AUTO SPEED TECH VIDEO

LOWERS SOUND LEVELS

Auto-speed technology provides a link from pump to engine, in effect when pressure cleaning is not taking place the engine will decrease to idle RPM speed and back up to optimal RPM full speed to achieve working pressure and flow for the Jetting process. Allowing you to get more out of your equipment putting it to work for longer ultimately effecting positively your bottom line.

BENEFITS

- 01 Optimises engine speeds to load.
- 02 Significantly extended run times.
- 03 Decreases fuel consumption.
- 04 Drastically decreased noise levels.
- 05 Less RPMs equals less maintenance costs.
- 06 Reduces emissions and exhaust gases.
- 07 Allows you to work day and night.
- 08 Fewer refueling trips.
- 09 Deliver maximum runtime.

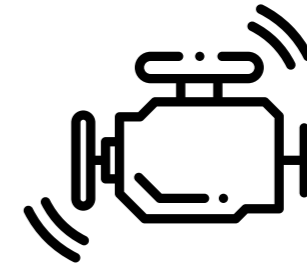

NON-OPERATIONAL SPEED



PERFORMANCE SPEED



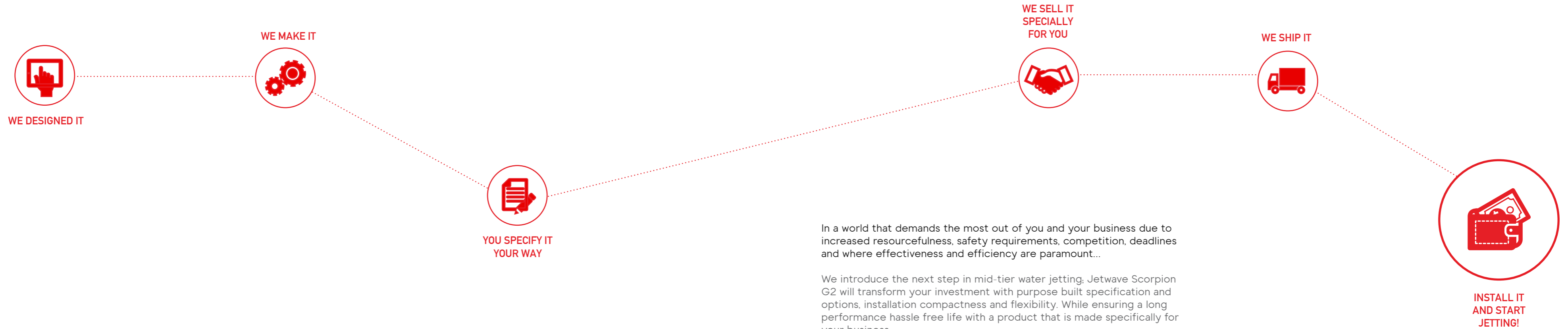

In a world that demands the most out of you and your business due to increased resourcefulness, safety requirements, competition, deadlines and where effectiveness and efficiency are paramount...

We introduce the next step in mid-tier water jetting; Jetwave Scorpion G2 will transform your investment with purpose built specification and options, installation compactness and flexibility. While ensuring a long performance hassle free life with a product that is made specifically for your business.

Empowering you with new possibilities to grow and diversify your plumbing business.

STANDOUT FEATURES



JW Professional Italian Pump



Low speed pump



V-TWIN HONDA™ Engine



Quick coupling system



DIY Heavy duty inlet water filter



Brass unloader valve

60M VIPERFLEX
Primary hose best in class performance.

JW PREMIUM ITALIAN PUMP
Jetwaves professional Italian triplex plunger pump delivers performance and longer life.

LOW SPEED PUMP
Low speed professional pump for increased reliability and longer maintenance intervals.

V-TWIN HONDA™
Industrial series OHV engine for maximum performance of the jetting machine.

CENTRALISED CONTROL FASCIA PANEL
All unit controls ergonomically mounted front facing for maximum mounting versatility and operator comfort.

FRAME STRUCTURE
Modular and compact precision CNC design incorporating provision for mounting kits.

STAINLESS STEEL EXOSKELETON (PEXO™)
Sturdy industrial formed stainless steel cover protection for durability and enduring component protection for the life of your investment

FORKLIFT INTEGRATED POCKETS
Easy mounting ability transportation via forklift around on-site.

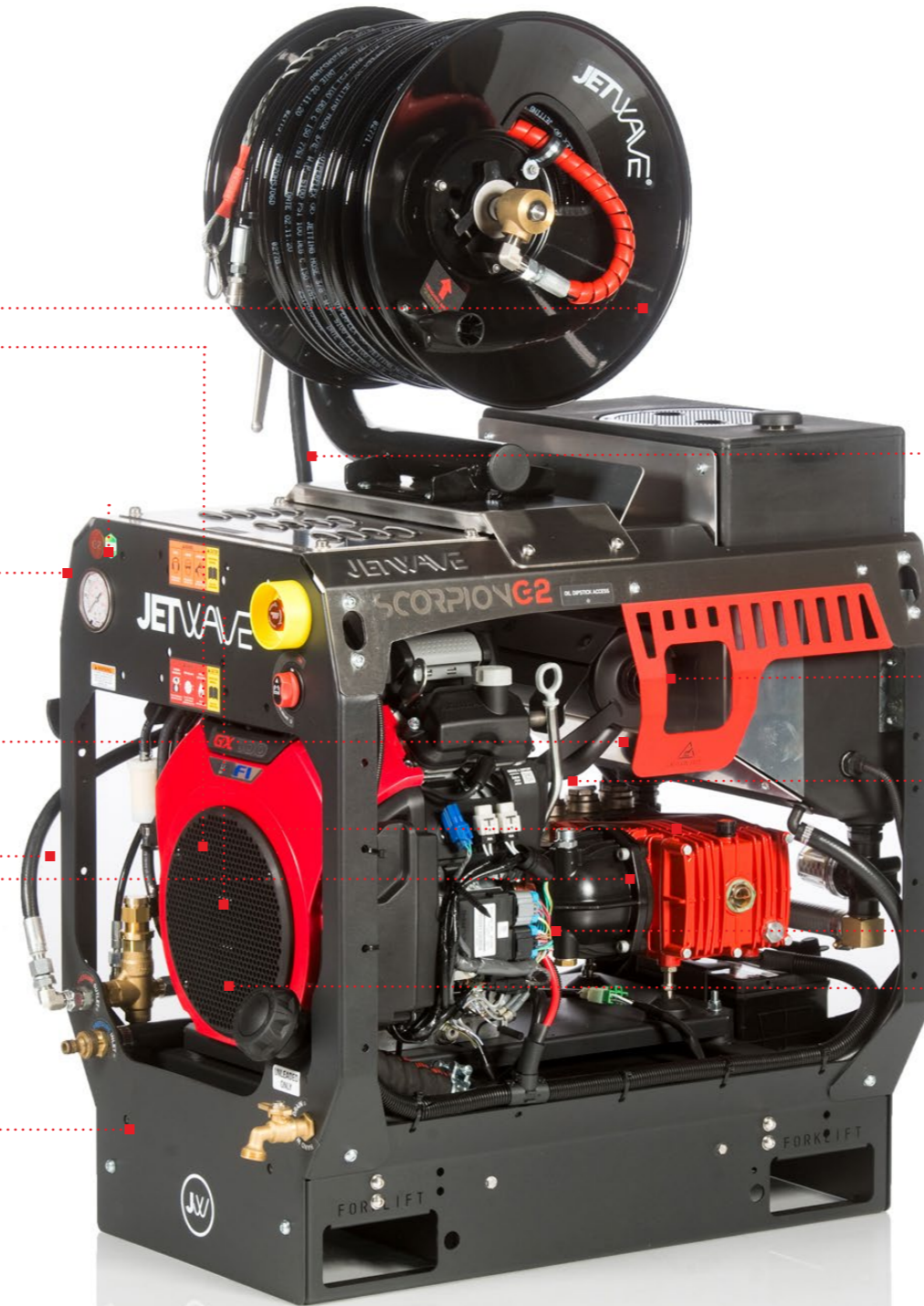

Emergency stop



Forklift/mounting pockets



Jetwave Safety System (JSS™)

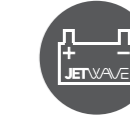

Battery isolator



Professional line accessories



Stainless steel pressure gauge

STANDOUT FEATURES

BATTERY ISOLATOR
For more on-site safety and make sure no battery is drained.

VIEWABLE HEAVY DUTY
Washable inlet water filter.

JETWAVE SAFETY SYSTEM (JSS™)
Safety valve to prevent overpressurisation.

EZY CLIP WHIP HOSE RESTRAINT
Safety system for primary hose.

WATER BYPASS TANK
40L On-board water bypass & feed tank.

ANTI-VIBRATION SYSTEM (AVPS™)
Boasts life expectancy and ensures a longer, quieter unit performance.

STAINLESS STEEL PRESSURE GAUGE
Stainless steel pressure gauge to ensure reliable pressure monitoring.

BRASS UNLOADER VALVE
For long life.

EMERGENCY STOP
For on site safety and emergency stop of the machine to prevent injuries or breakages.

HYGENIC HAND WASH
Front facing tap for quick hand washing.

FUEL TANK
Easy fill 25L fuel tank with level gauge.

PAYBACKS IN INNOVATION YOU CAN TAKE TO THE BANK

Operator safety and functionality greater than ever before.

Larger performances & features.

Reduce expenses and downtime.

Choice of performances
4000 - 5075 PSI at 16 - 31 L/PM.

Improve productivity and job site safety.

Optimise space via configurations, meaning more room in your van, truck or work trailer for other job site tools and equipment.

Decreased risk of operator error.

Maintenance costs squeezed.

Lower cost of ownership long term.
Product longevity.

Investment protected.

Jobs done faster, safer and more efficient.

Versatility across mounting/vehicle configurations to provide space savings.



Seamlessly mount your way.

OVER **15** SOLUTIONS
1 PRODUCT

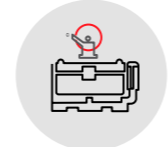

SKID MOUNT

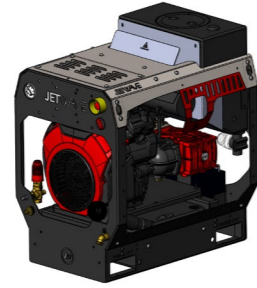

1.0 Skid - No Reel



1.1 Skid - Top Hose Reel



1.2 Skid - Top Hose Reel with Roller Guide (HGS™)

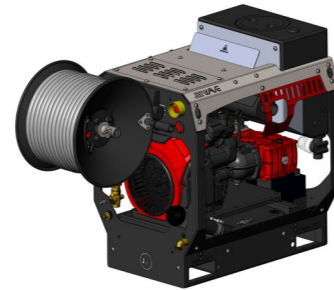

1.3 Skid - Front Hose Reel

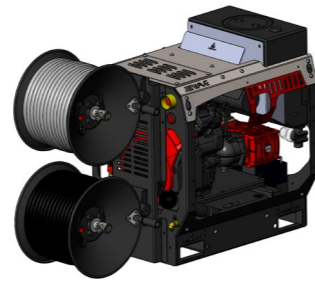

1.4 Skid - Front Double Stacked Hose Reels

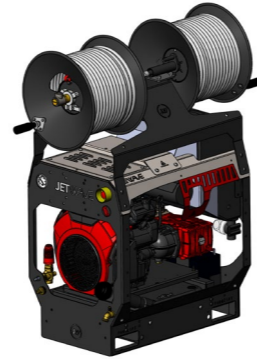

1.5 Skid - Top Double Stack Hose Reels



TROLLEY MOUNT



2.1 Trolley Kit - With Roller Guide

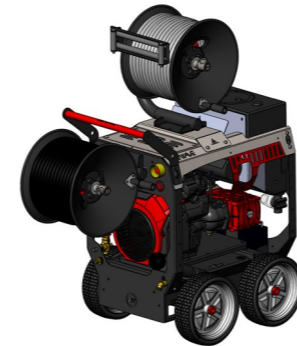

2.1 Trolley Kit - With Roller Guide & Front Hose Reel

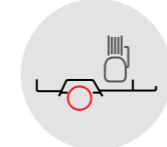

TRAILER MOUNT

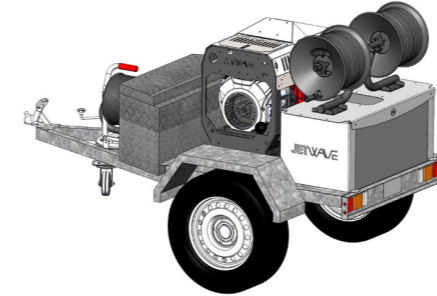

3.0 Trailer - Double hose reels & large tool box & 200L tank

READ MORE ABOUT THE SCORPION G2
TRAILER BROCHURE

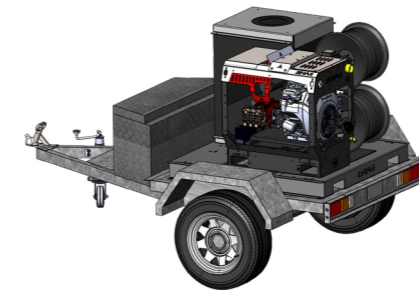

UTE MOUNT

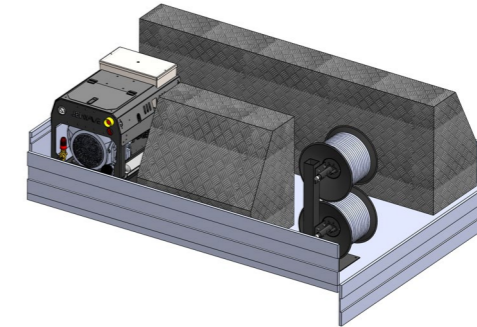

4.0 Ute - Standard

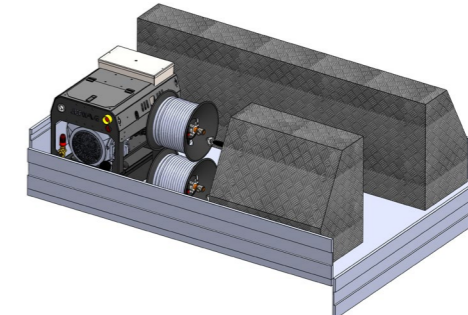

4.1 Ute - With Double Stack

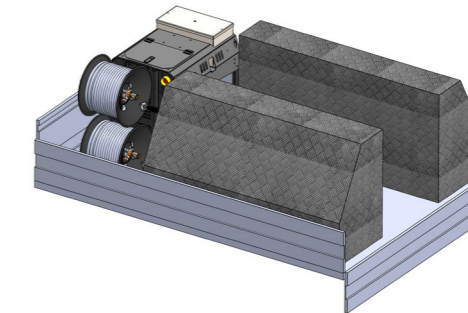

4.2 Ute - Front Double Stack (on unit)



VAN MOUNT

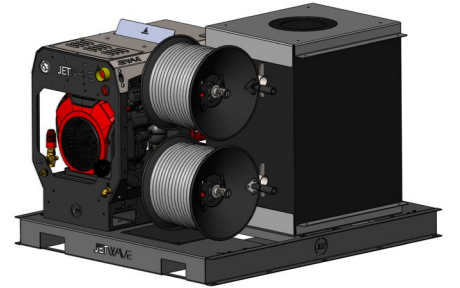

5.0 Skid Cube - Double Stacked Hose Reels, Water Tank & Skid

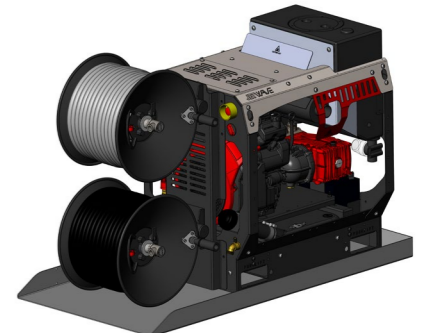

5.1 Skid Van Pack - Double Stacked Front Hose Reels with Drip tray and modified exhaust

PRO RAPID STYLE HOSE REEL



80M Pro Rapid Style Primary Reel with 60m 3/8" Viperflex hose, with safety restraint sock.

WATER BYPASS TANK



40L Water bypass & feed tank.

PROFESSIONAL NOZZLE KIT



- 1 x Reverse Root Cutter
- 1 x Penetrator
- 1 x Negotiator
- 1 x Negotiator (small)
- 1 x Adapter
- 1 x Multi-tool Spanner
- 1 x Nozzle Tip Cleaner
- 1 x Extension Bar
- 1 x Extra Heavy IP68 Duty Carry Case

SPRAY GUN & LANCE



Wash down spray gun and lance.

HONDA iGX700 FUEL INJECTED MOTOR UPGRADE



Intelligent electronic fuel injected Honda motor upgrade that comes with auto speed technology.

P/N: JWA-F12

DOUBLE TOP STACK KIT



Main package with primary high pressure reel top mounted + low pressure feed reel top mounted for rear or side access.

P/N: JWA-430

DOUBLE STACKED FRONT HOSE REEL KIT

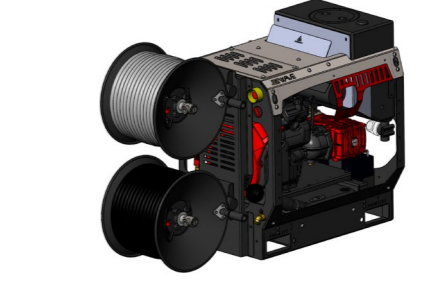

Main package with primary HP reel front mounted + double stack kit for low pressure feed reel front mounted.

P/N: JWA-429

TOP AND FRONT HOSE REEL KIT

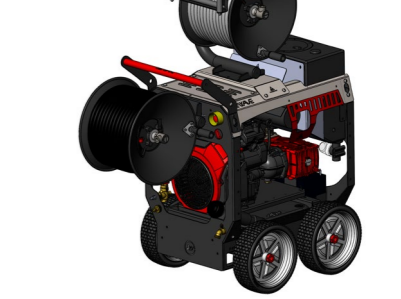

Main package with primary high pressure reel top mounted + low pressure feed reel front mounted + hose roller guide system + 4 wheel trolley kit.

P/N: JWA-407A + 1065CMPLLP + JWA-HGS

ENGINE HOUR METER



Integrated engine hour meter attached to the Honda engine to give hours used for optimal servicing.

EMERGENCY STOP



To quickly shut down the entire machine for maximum safety and to meet certain site safety standards.

LOW LEVEL WATER CUT OUT



Water tank cut out protection to, stops the machine when water level gets too low in the tank to protect the pump.

BATTERY ISOLATOR



For more onsite safety and to meet certain site safety standards

VAN MOUNT KIT

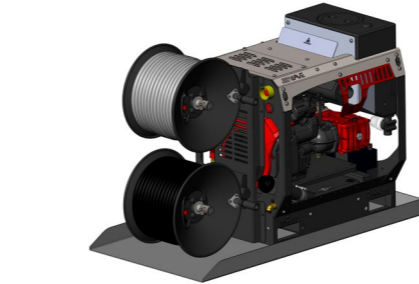

Kit includes; Van drip tray, low pressure inlet reel & modified exhaust.

P/N: JWA-432

TROLLEY KIT



Trolley kit for portability of the jetter, kit includes; hardware, 4 x offroad puncture proof wheels, 2 x axles, 4 x wheel locking collar, soft grip handle

P/N: JWA-407A

LOW PRESSURE REEL



Low pressure feed reel with 30m of low pressure hose, lead hose & mounting hardware.

P/N: 1065CMPLLP

HGS - HOSE ROLLER GUIDE SYSTEM



Hose reel guide mounted onto the hose reel with roller guides.

P/N: JWA-HGS



REMOTE MINI REEL



Portable remote reel with 60m of 1/4" viperflex hose. Snap coupling, ball valve, pressure gauge and electro-less polished stainless steel frame.
 P/N: PW134-RRCMPL/HOP4CMPL
 LOCKING PLATE: P/N: 90012HRH-LP

FORWARD ROOT CUTTING NOZZLE

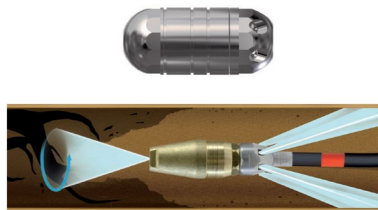

Forward root cutting nozzle.
 P/N: C43RS

15M VIPERFLEX FLEXIBLE WHIP HOSE



15m of whip hose.
 P/N: HOP3VFX15-ASSY

DOUBLE STACKED APACHE HOSE REEL KIT



Double stacked 100m apache a-frame premium hose reels
 P/N: 2100437

STAINLESS STEEL PRIMARY HOSE REEL (60M)



Upgrade primary jetting reel to stainless steel.
 P/N: 1067CMPLSS

APACHE 12V REWIND KIT

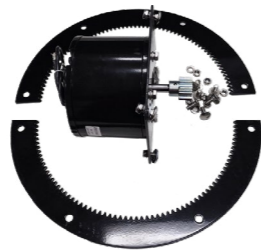

12v electronic rewind kit to suite apache hose reels.
 P/N: JWA420

APACHE A-FRAME HOSE REEL



Apache A-Frame hose reel capacity of 100m (no hose included). Optional hose reel guides
 P/N: JWA120
 HOSE REEL GUIDES: P/N: 2100503

DOUBLE STACKED HOSE REEL KIT



Double stacked pro rapid style hose reels.
 P/N: JWA-90175

CLASS B DOUBLE ACTION FOOT VALVE KIT



Adheres to Class B AZNS regulations, foot valve kit for hands free safe jetting control.
 P/N: 90171CMPL

PREMIUM DANGER SIGN



Premium wind resistant safety sign with heavy base plate.
 P/N: JWA316

JETTING SAFETY PLATE



Jetting safety plate
 P/N: JSP

500 BAR TST PPE SAFETY PACK



Helmet with ear muff and visor protection + gloves

CONCEPT SKETCH

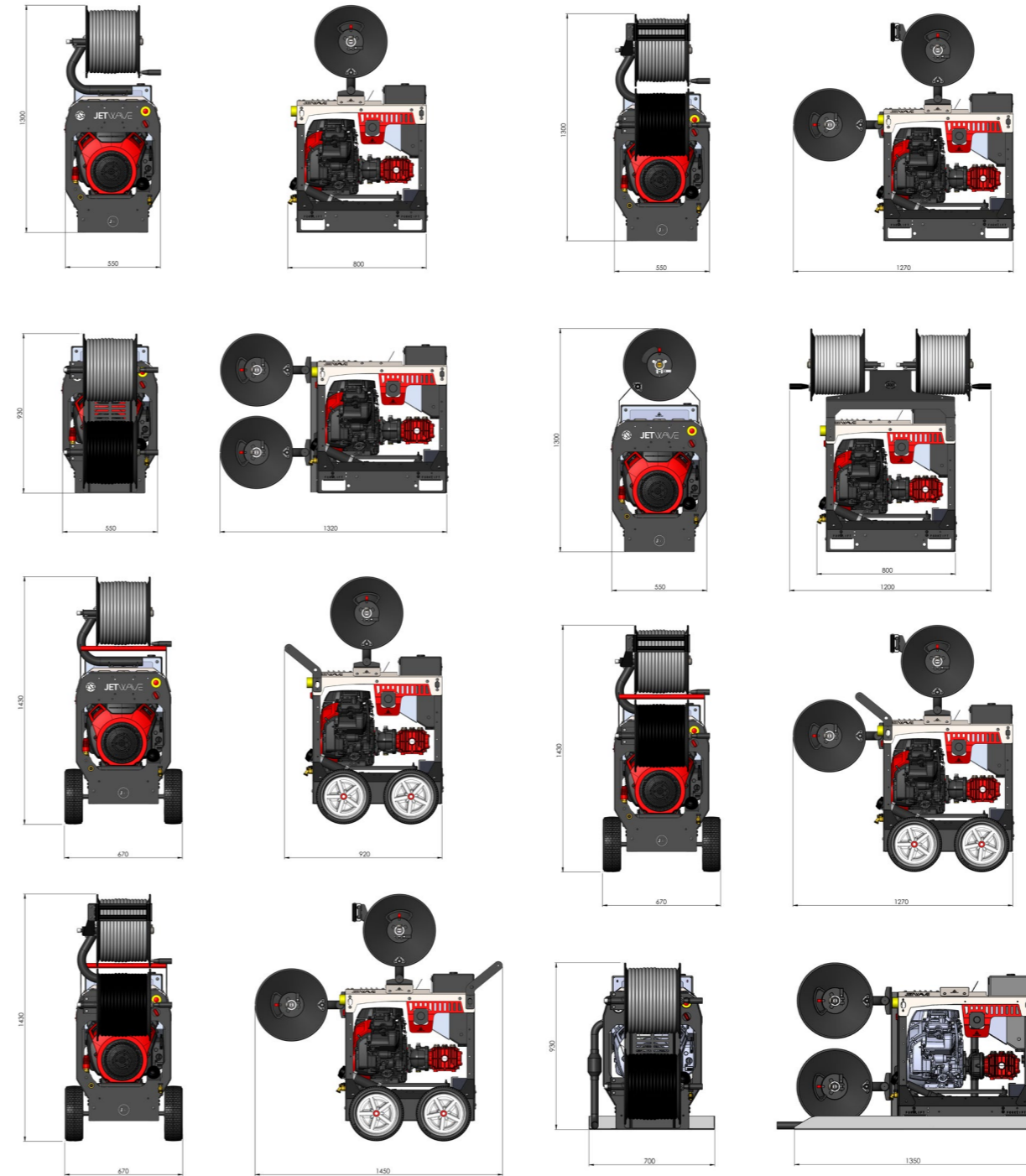
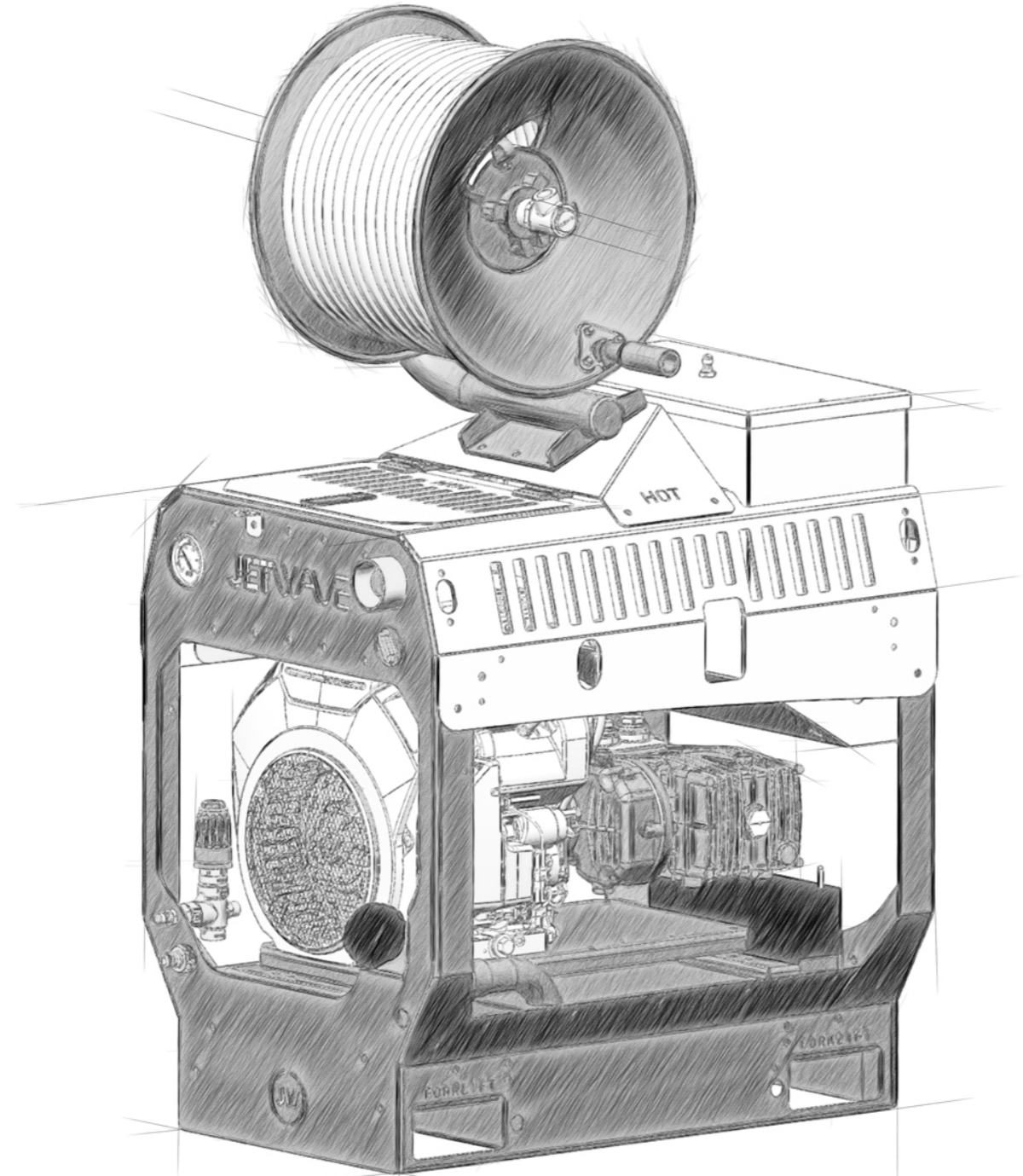

CRITICAL DIMENSIONS

Scorpion G2 represents better equipment for a better world. Our dedicated and passionate team aim to revolutionise the industry in which we operate in, therefore creating a professional value added product:

- To provide more results for your customers.
- Build job satisfaction and sustainability.
- Build your business by reducing expenses and adding to the bottom line.
- Build progress with better equipment for users contributing to a smarter, safer and more efficient world.

MOUNTING DATA

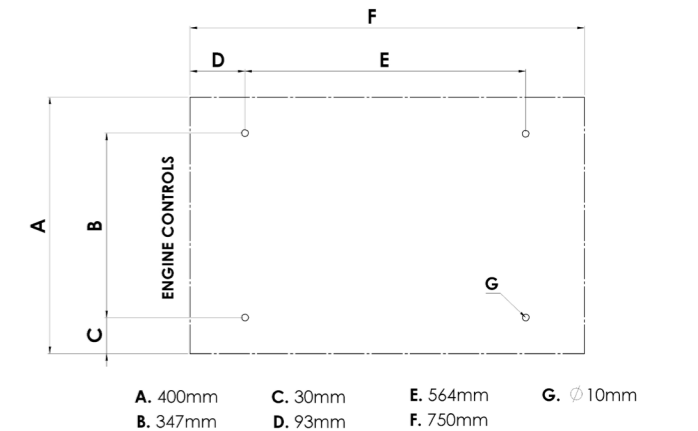



SCORPION G2



SCORPION G2



SCORPION G2



SCORPION G2

Product Code	p/n	HJ4000-20PH	HJ4350-26PH	HJ5000-16PH	HJ5000-23PH
TECHNICAL DATA					
Working Pressure	psi / bar	4000 / 275	4350 / 300	5000 / 345	5075 / 350
Flow Rate	l/min	20	26	16	23
Max Inlet Temperature	°c / °f	60 / 140	60 / 140	60 / 140	60 / 140
Class (AS/NZS 4233.1:2013)	class	A (5,500 BAR/LITRES)	B (7,800 BAR/LITRES)	A (5,520 BAR/LITRES)	B (8,050 BAR/LITRES)
MOTOR FEATURES					
Engine	type	HONDA™ GX630 (4 stroke, air cooled)	HONDA™ GX690 (4 stroke, air cooled)	HONDA™ GX630 (4 stroke, air cooled)	HONDA™ GX690 (4 stroke, air cooled)
Power	hp / cc	21 / 630	22 / 690	21 / 630	22 / 690
Starting System	type	Electric key start	Electric key start	Electric key start	Electric key start
Hour Metre	y / n	Y	Y	Y	Y
Fuel supply	type	Unleaded	Unleaded	Unleaded	Unleaded
Fuel Capacity	litres	25	25	25	25
Low Oil Shutdown	y / n	Y	Y	Y	Y

HYDRAULIC FEATURES

Pump / Head / Pistons / Valves	type / material	JW® Italian Triplex Plunger/Brass (Nickle Plated)/Ceramic	JW® Italian Triplex Plunger/Brass (Nickle Plated)/Ceramic	JW® Italian Triplex Plunger/Brass (Nickle Plated)/Ceramic	JW® Italian Triplex Plunger/Brass (Nickle Plated)/Ceramic
Motor Pump Coupling	type	Gearbox Drive	Gearbox Drive	Gearbox Drive	Gearbox Drive
Pump Speed	rpm	1450	1450	1450	1450
Unloader Valve	type / material	Independent	Independent	Independent	Independent
Safety Valve	y / n	Y	Y	Y	Y
Orifice / Nozzle	size	05	065	04	055

OTHER FEATURES

Adjustable Pressure	y / n	Y	Y	Y	Y
Hose Reel Provision	y / n	Y (3 positions)	Y (3 positions)	Y (3 positions)	Y (3 positions)
Frame Structure	type	CNC Modular skid with heavy gauge galavnised steel chassis and stainless steel cover	CNC Modular skid with heavy gauge galavnised steel chassis and stainless steel cover	CNC Modular skid with heavy gauge galavnised steel chassis and stainless steel cover	CNC Modular skid with heavy gauge galavnised steel chassis and stainless steel cover
Onboard Accessory Storage	y / n	Y	Y	Y	Y

WARRANTY(S)

Engine Warranty	years	3	3	3	3
Pump Warranty	year	3	3	3	3

*Coverage against defects in material and workmanship (refer to Jetwave's and component partners T&Cs).

PACKING DETAILS

DIMENSIONS AND WEIGHT

Approx weight	kg	195 unit / 220 boxed	195 unit / 220 boxed	195 unit / 220 boxed	195 unit / 220 boxed
Unit Dimensions	mm	800(L) x 550(W) x 1300(H)	800(L) x 550(W) x 1300(H)	800(L) x 550(W) x 1300(H)	800(L) x 550(W) x 1300(H)
Box Dimensions	mm	1000(L) x 800(W) x 1350(H)	1000(L) x 800(W) x 1350(H)	1000(L) x 800(W) x 1350(H)	1000(L) x 800(W) x 1350(H)
<small>*Add 120mm to height for pallet.</small>					

Number per Pallet	type: pieces	Custom: 1	Custom: 1	Custom: 1	Custom: 1

The manufacturer reserves the right to modify design features and technical facts without notice, due to our principals of continuous improvement.



SCORPION G2FI



SCORPION G2FI

Product Code	p/n	HJ4000-31PHFI	HJ5000-25PHFI
--------------	-----	---------------	---------------

TECHNICAL DATA

Working Pressure	psi / bar	4060 / 280	5075 / 350
Flow Rate	l/min	31	25
Max Inlet Temperature	°c / °f	60 / 140	60 / 140
Class (AS/NZS 4233.1:2013)	class	B (8.680 BAR/LITRES)	B (8.750 BAR/LITRES)

MOTOR FEATURES

Engine	type	HONDA™ iGX800 (4 stroke, air cooled)	HONDA™ iGX800 (4 stroke, air cooled)
Power	hp / cc	25 / 800	25 / 800
Starting System	type	Electric key start	Electric key start
Hour Metre	y / n	Y	Y
Fuel supply	type	Unleaded	Unleaded
Fuel Capacity	litres	25	25
Low Oil Shutdown	y / n	Y	Y

HYDRAULIC FEATURES

Pump / Head / Pistons / Valves	type / material	JW® Italian Triplex Plunger/Brass (Nickle Plated)/Ceramic	JW® Italian Triplex Plunger/Brass (Nickle Plated)/Ceramic
Motor Pump Coupling	type	Gearbox Drive	Gearbox Drive
Pump Speed	rpm	1450	1450
Unloader Valve	type / material	Independent	Independent
Safety Valve	y / n	Y	Y
Orifice / Nozzle	size	08	055

OTHER FEATURES

Adjustable Pressure	y / n	Y	Y
Hose Reel Provision	y / n	Y (3 positions)	Y (3 positions)
Frame Structure	type	CNC Modular skid with heavy gauge galavnised steel chassis and stainless steel cover	CNC Modular skid with heavy gauge galavnised steel chassis and stainless steel cover
Onboard Accessory Storage	y / n	Y	Y

WARRANTY(S)

Engine Warranty	years	3		3	
Pump Warranty	year	3		3	

*Coverage against defects in material and workmanship (refer to Jetwave's and component partners T&Cs).

PACKING DETAILS

DIMENSIONS AND WEIGHT

Approx weight	kg	200 unit / 220 boxed	200 unit / 220 boxed
Unit Dimensions	mm	800(L) x 550(W) x 1300(H)	800(L) x 550(W) x 1300(H)
Box Dimensions <small>*Add 120mm to height for pallet.</small>	mm	1000(L) x 800(W) x 1350(H)	1000(L) x 800(W) x 1350(H)
Number per Pallet	type: pieces	Custom: 1	Custom: 1



The manufacturer reserves the right to modify design features and technical facts without notice, due to our principals of continuous improvement.

@jetwave.group
#imagineCLEAN
#JetwaveScorpionG2



📍 10 - 16 Smith Street | Thebarton | Adelaide | South Australia | 5031 | AU
☎ +61 8 8371 3599 | ✉ sales@jetwave.com.au | 🌐 www.jetwavegroup.com



V2.1 05/2021

Jetwave® and Scorpion™ G2 are registered trademarks of Jetwave® Group Pty Ltd.

Distributed by:

For more information on our products, please visit jetwavegroup.com